

2023 INNOVATIONS



BLACK GREEN

IMPRESSIVE
inspired by ...
COLOURS



nolte[®]

KÜCHEN



MANHATTAN UNI

Black green

BY NATURE

ELEGANCE



MANHATTAN UNI

Black green



Base and tall units can also be upgraded with LED lighting recessed in the side.



Light in the right place!
As from the 2023 collection
our top panels are
available with integrated
lighting ex-works.



nolte[®]
KÜCHEN



FRONT LACK / SOFT LACK

Black green soft mat

BY NATURE
DURABLE



FRAME LACK / SOFT LACK

Black green soft mat



The new black green colour shade is also available in our mat lacquer concept.



LAVA SOFT MAT

UNIQUE
inspired by ...
ELEMENTS



nolte[®]
KÜCHEN



PLUS Lava soft mat
MANHATTAN Oak graphite silver

BY NATURE
**PERFECTLY
BALANCED**



PLUS Lava soft mat
MANHATTAN Oak graphite silver



Borrowed from nature, two decors in perfect harmony: PLUS in lava soft mat with the easy-care anti-fingerprint surface finish combined with distinctive MANHATTAN oak graphite silver



FINE LACK

FASCINATING
inspired by ...
SURFACES



nolte[®]

KÜCHEN



FINE LACK High-gloss platinum grey
TAVOLA Oak barolo

BY NATURE
BRILLIANCE



FINE LACK High-gloss platinum grey
TAVOLA Oak barolo

Clever detail solution:
The combination of 25 mm
panels in gloss platinum grey
and the 12 mm panel in oak
barolo make a homely statement.

Introducing the new FINE
LACK range, we are adding
a high-gloss genuine lacquer
in four sales-boosting colour
finishes to price group 4.



LUGANO LACK

AUTHENTIC
inspired by ...
TEXTURES



nolte[®]

KÜCHEN



LUGANO LACK

Magma soft mat

BY NATURE
STYLED



LUGANO LACK
Magma soft mat

The new LUGANO LACK genuine wood front in magma soft mat seamlessly complements our modern country-style line-up.



The high-quality impression of this kitchen composition is complemented by the elegant black display cabinets with integrated lighting.

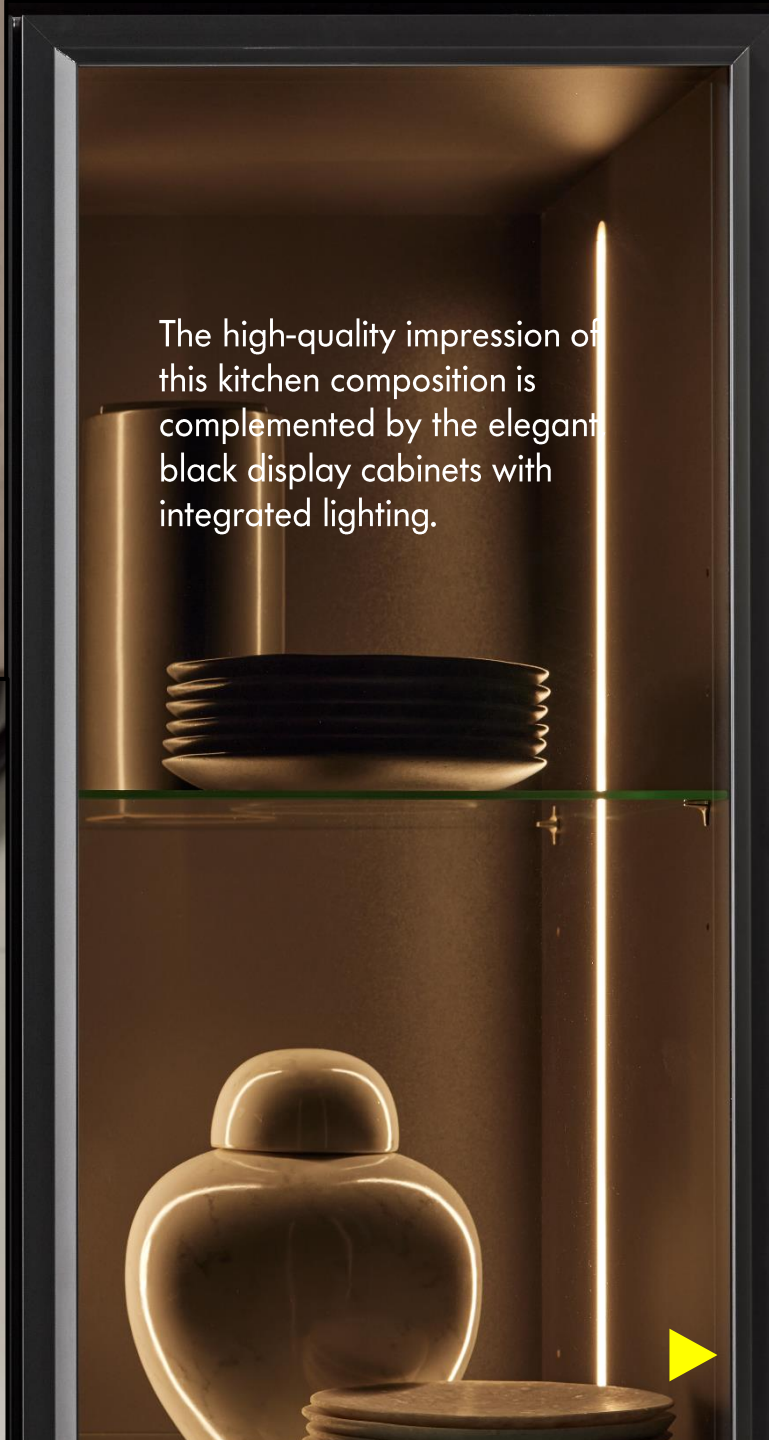

nolte[®]

KÜCHEN



LUGANO LACK
Henna red soft mat

BY NATURE
INDIVIDUALITY



LUGANO LACK
Henna red soft mat

Our new LUGANO LACK is another modern interpretation of the framed look in genuine wood. Combining it with black handles and a worktop in basalt look gives the kitchen a particularly unique feel with unusual nuances.

All of the surrounding elements are available in reproduction ash with fine wood graining.

With its authentic graining, LUGANO LACK in henna red perfectly underscores this kitchen's modern country style.



NOLTE NOLTE KÜCHEN BY NATURE

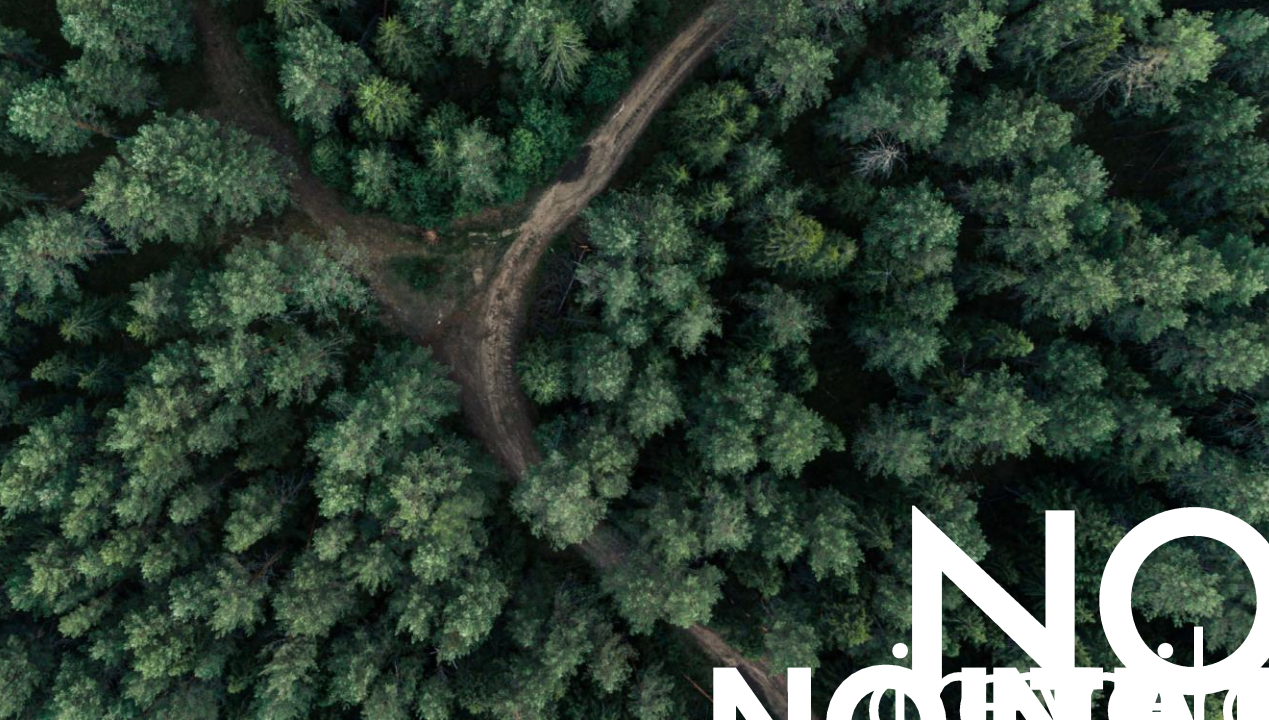

Innovations 2023

PG 1

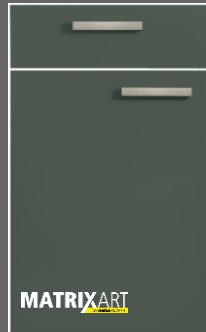

MANHATTAN UNI
Black green
Melamine resin mat

PG 3

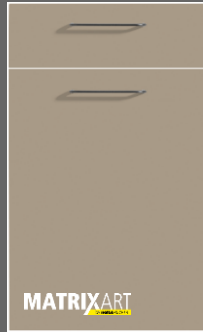

PLUS
Lava soft mat
Laminate with anti-fingerprint finish

PG 4



FINE LACK
High-gloss arctic white
Genuine lacquer



FINE LACK
High-gloss white
Genuine lacquer

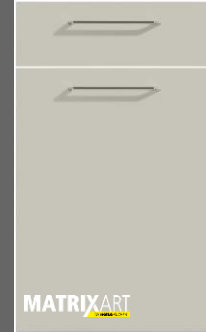

FINE LACK
High-gloss platinum grey
Genuine lacquer

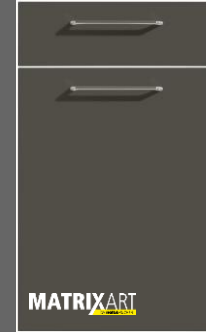

FINE LACK
High-gloss graphite
Genuine lacquer

PG 7



LUGANO LACK
Real ash
Genuine lacquer
soft mat

MAT LACQUER CONCEPT



LUGANO LACK is the new star in our mat lacquer concept. Black green as a new colour shade in the mat lacquer concept is available for all front designs.



Available from
March 2023





Display kitchens **FINE LACK**

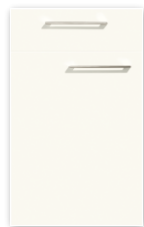

LUX High-gloss white **Price group 2**

Front: 361 High-gloss white
 Carcase: PWG Gloss premium white

Visible side: D2 G79 Gloss white
 Plinths: D2 G79 Gloss white
 Panels: D2 G79 Gloss white

Surrounding elements: D2 G79 Gloss white



FINE LACK High-gloss white **Price group 4**

Front: 521 High-gloss white
 Carcase: PWG Gloss premium white

Visible side: D2 G79 Gloss white
 Plinths: D2 G79 Gloss white
 Panels: D2 G79 Gloss white

Surrounding elements: D2 G79 Gloss white



NOVA LACK High-gloss white **Price group 6**

Front: 731 High-gloss white
 Carcase: PWG Gloss premium white

Visible side: D6 LGW Lacquer, gloss white
 Plinth: D6 LGW Lacquer, gloss white
 Panels: D6 LGW Lacquer, gloss white
 (genuine lacquer on all sides)

Surrounding elements: D6 LGW Lacquer, gloss white





Display
kitchens

FINE LACK

Recommendations for re-positioning and substituting TREND LACK

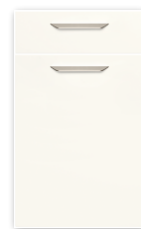

FINE LACK High-gloss white **Price group 4**

Front: 521 High-gloss white
 Carcase: PWG Gloss premium white
 Visible side: D2 G79 Gloss white
 Plinths: D2 G79 Gloss white
 Panels: D2 G79 Gloss white
 Surrounding elements: D2 G79 Gloss white

Recommendation: substitute for TREND LACK

- Display kitchen only contains front TREND LACK → Front changed to FINE LACK or new plan
- Display kitchen contains the TREND LACK front, Visible sides and/or panels in LUW UV lacquer, gloss white (altern. LUA UV lacquer, gloss arctic white) → new plan FINE LACK
- Display kitchen only contains front in magnolia → new plan FINE LACK in one of the 4 front colours



Being discontinued in 2023

PG 1



MANHATTAN UNI
Lavender

PG 2



TITAN
Mother-of-pearl



TITAN
Graphite

PG 3

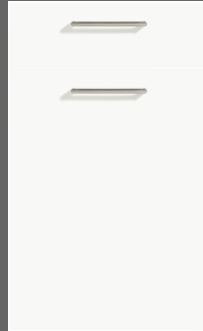

TREND LACK
High-gloss arctic white



TREND LACK
High-gloss white

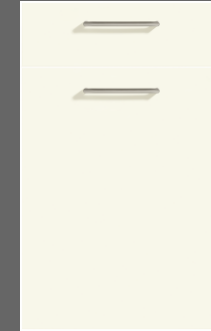

TREND LACK
High-gloss magnolia

PG 3



VEGAS
Milled stainless steel



VEGAS
Milled manganese bronze

MAT LACQUER



Gorse



Curry

WORKTOPS



TITAN Mother-of-pearl



TITAN Graphite



Mocha ash

12 mm thick

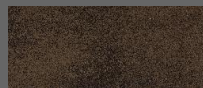

Copper oxide



Natural bough oak



Walnut royal



Rustic wild oak



Walnut cuba





Vanity units

New unit models

Height 750 mm

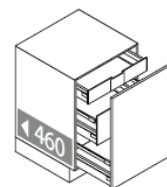

Pull-out unit

- 1 interior drawer
- 1 interior pull-out
- 1 pull-out

Carcase depth 460 mm

UATDISA 30/40/45/50/60 – 75-50

Carcase depth 560 mm

UATDISA 30/40/45/50/60

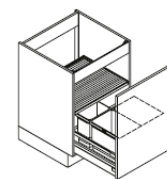

Sink base unit with waste serparation system

- 1 pull-out
- 1 cover panel
- 1 base panel with fixation nubs
- 4 bins
- 1 organic lid for bins, 8 litres

Carcase depth 560 mm

SABD 60-4A

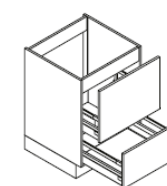

Sink base unit without waste separation system

- 1 pull-out
- 1 pull-out, reduced in depth
with U-bend cut-out
- 1 pull-out

Carcase depth 560 mm

SAZ 60/80/90/100/120 - 03

MATRIXART

Carcase depth 560 mm

YSABD 60-4A



MatrixArt ONE Dishwasher front

notte **neo**

Available from
01.11.2022

Height 750 mm

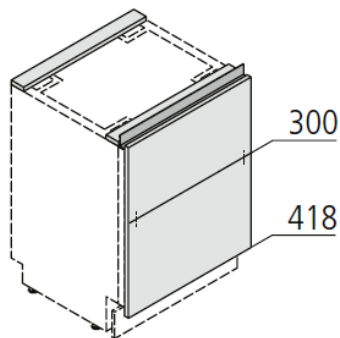

Door front for fully integratable dishwasher

Door front pin-joined 418 + 300 including spacer strip,
20 mm behind the front panel as height compensation

Appliance height 820 mm
can be used from plinth height of 100 mm

Appliance height 870 mm
can be used from plinth height of 170 mm

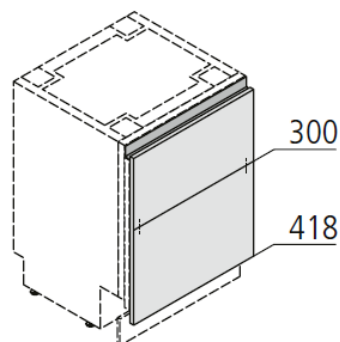

Door front for fully integratable dishwasher

doubled front with spacer frame and
integrated finger pull profile

Front panel pin-joined 418 + 300



Electric drive (EMA)

now for even more unit models

for lift-up door fitting

For following unit models
additionally possible:

Top-mounted units	HAL ...
Appliance units	GKL ...
Appliance units	GBL ...

New generation of flap-door hinges

easy and convenience to use

Applies to following unit models:

Pivoting flap door units	HL ...
Folding flap door units	HFK ...
Top-mounted units	HAL ...
Tall units	GKL ... / GBL ... / YGG ...

Display kitchens with HL... will be supplied with new fitting from week 40.

**Changeover on
01.01.2023**

nohte[®]
KÜCHEN



Greater flexibility

from added carcass depths

Top-mounted unit / addition

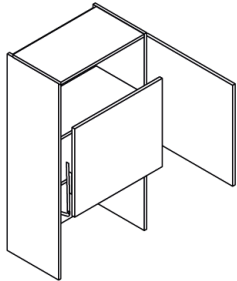

1 door, 1 adjustable shelf, 1 lift-up door
(hole for handle must be drilled on site),
2 SCHUKO earthed sockets

Carcass depth 350 mm Carcass depth 460 mm

HAL 60 - 115

HAL 60 - 130

HAL 60 - 145

HAL 60 - 115 - 48

HAL 60 - 130 - 48

HAL 60 - 145 - 48

Vertical finger pull profile / addition

for **HAL ... / HASK ... / HASKV ... / HAVDN ...**

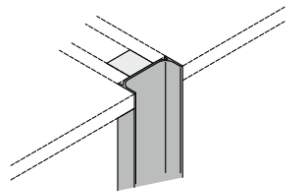

Vertical finger pull C-profile

for carcass height 1160 - 1188 mm **YP - C - 115**

for carcass height 1310 - 1338 mm **YP - C - 130**

for carcass height 1460 - 1488 mm **YP - C - 145**

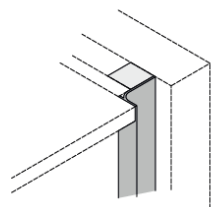

Vertical finger pull L-profile

for carcass height 1160 - 1188 mm **YP - L - 115**

for carcass height 1310 - 1338 mm **YP - L - 130**

for carcass height 1460 - 1488 mm **YP - L - 145**

Vertical finger pull C-profile

for carcass height 1160 - 1188 mm with lighting **YP - C - 115 - EMO**

for carcass height 1310 - 1338 mm with lighting **YP - C - 130 - EMO**

for carcass height 1460 - 1488 mm with lighting **YP - C - 145 - EMO**

Vertical finger pull L-profile

for carcass height 1160 - 1188 mm with lighting **YP - L - 115 - EMO**

for carcass height 1310 - 1338 mm with lighting **YP - L - 130 - EMO**

for carcass height 1460 - 1488 mm with lighting **YP - L - 145 - EMO**

Available in the following colours:

- 598** Artic white
- 790** Premium white
- 595** Stainless steel look
- 593** Quartz grey
- 591** Black



nolte[®]
KÜCHEN



Tall units

New generation of fittings

Height-adjustable shelves on the door

Heights 1350 / 1500 / 1950 / 2100 / 2250 mm

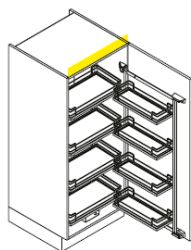

Larder unit with storage baskets

1 door with 4 adjustable shelves and 4 adjustable shelves that move towards the front when the door is opened

Note: observe max. loading capacity
Pull-out shelf 40 kg, door shelf 16 kg!

Models

VVK 60-135 R/L
VVK 60-150 R/L
VVKD 60-150 R/L

Front layout

1350
750/750
1500

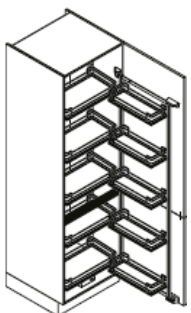

Larder unit with storage baskets

1 door with 5 adjustable shelves and 5 adjustable shelves that move towards the front when the door is opened

Note: observe max. loading capacity
Pull-out shelf 40 kg, door shelf 16 kg!

Models

VVK 60-195 R/L
VVK 60-195-H R/L
VVKD 60-195 R/L

Front layout

750/1200
1350/600
1950

VVK 60-210 R/L
VVK 60-210-H R/L
VVKD 60-210 R/L

750/1350
1350/750
2100

VVK 60-225 R/L
VVK 60-225-H R/L
VVKD 60-225 R/L

750/1200/300
1350/900
2250



In future also in:

TAB - neoBOX version for pull-out shelves

Changeover
from week 40



nohte[®]
KÜCHEN

Tall units

Pull-out shelf changeover for VVA..., VDK..., VVK...

Heights 1050 / 1350 / 1500 / 1950 / 2100 / 2250 mm

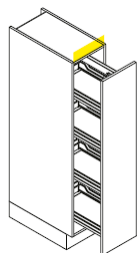

Height	VVA...		VDK...		VVK...	
	NOW	FUTURE	NOW	FUTURE	NOW	FUTURE
1050	3	3	-	-	-	-
1350	3	4	4	4	4	4
1500	4	4	4	4 + shelf at top	4	4 + shelf at top

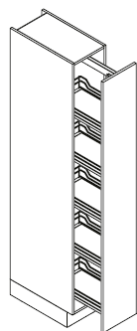

Height	VVA...		VDK...		VVK...	
	NOW	FUTURE	NOW	FUTURE	NOW	FUTURE
1950	5	5	6	5	6	5
2100	5	5	6	5 + shelf at top	6	5 + shelf at top
2250	6	6	6	5 + shelf at top	6	5 + shelf at top



Tall units

New unit models

New generation of appliance units for aperture height of 178 (GK...179-... no longer available) Bottom structural shelf in a thickness of 25 mm (where technically possible) in carcass colour QGD

Heights 1950/2100/2250 mm

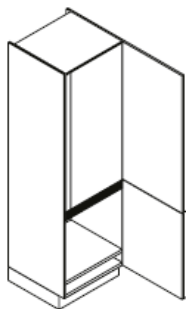

Appliance unit

1 aperture with pin-joined door for integrated refrigerator, 1780 mm, 1 fixed shelf

Models

GK 195-178 R/L
GK 195-178-01 R/L

Front layout

750/1200
900/1050

GK 210-178 R/L
GK 210-178-01 R/L

750/1350
900/1200

GK 225-178 R/L
GK 225-178-01 R/L

750/1200/300
900/1350

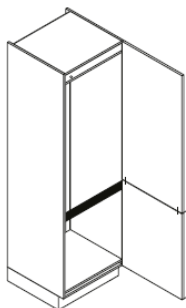

Appliance unit for EMA-GK

1 aperture with pin-joined door for integrated refrigerator, 1780 mm, 1 fixed shelf

Models

GK 195-178-E R/L
GK 195-178-01E R/L

Front layout

750/1200
900/1050

GK 210-178-E R/L
GK 210-178-01E R/L

750/1350
900/1200

GK 225-178-E R/L
GK 225-178-01E R/L

750/1200/300
900/1350



Appliance units Change to aperture height 3 + 4

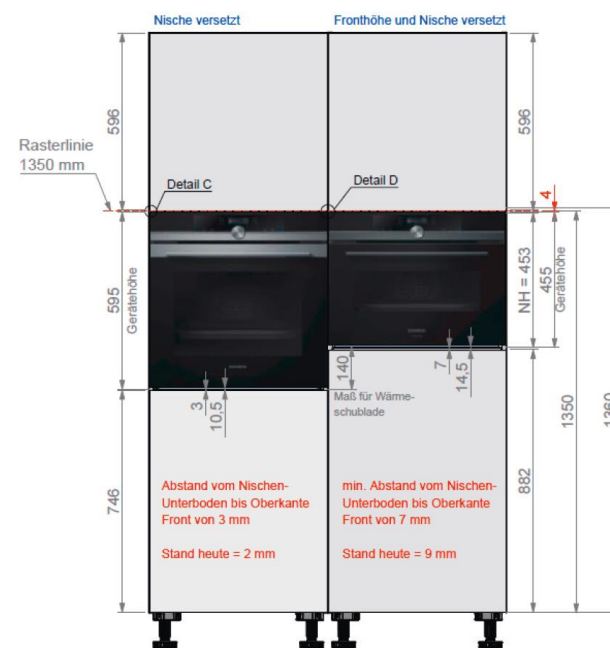

The mirror dimensions are being adjusted as a result of different appliance positions in adjacent appliance units.

In all **NH 3** (single niche 595 mm) appliance units, the bottom panel is being moved up by 1 mm (mirror dimension 3 mm) and the top panel is being moved down by 1 mm. (no need for 5 mm compensation strips)
Appliance unit with NH 3 = 83 each

In all appliance units with **NH 4 and suffix -H** (flush at top), the bottom panel is being moved down by 2 mm. (this leaves unit combinations with appliances **NH 3 + NH 4** flush at top)
Appliance units with NH 4 and -H = 18 each





Handles

Without additional charges

Hole spacing 192 mm



G 217
Black, metal
◊ ◊ 192 mm



G 349
Stainless steel look, metal
◊ ◊ 192 mm



G 8CB
Stainless steel look, metal
◊ ◊ 192 mm



Added components

New **PUSH-TO-OPEN**

PUSH-TO-OPEN



New design, stronger magnetic attraction
Can also be fitted for two-door units
Additional screw-on position for posts

MP-PTO-TUER

Additional charge for PUSH-TO-OPEN for a door
Uncushioned hinges to be fitted on site

PUSH-TO-OPEN

PUSH-TO-OPEN accessory pack
Uncushioned hinges to be fitted on site
(hinges are contained in accessory pack)

MP-PTO-KLAPPE

Additional charge for PUSH-TO-OPEN for a flap door
Flap height 300/400 mm

PTO-WW-SCHARN

Uncushioned hinges to be fitted on-site
for HE 65.../HE 80.../HE 90...

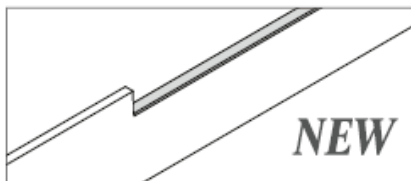

Cover profile for GSP cutout (plinth panels)

SOB-ABD70 700 mm
SWZ Black + ESO Stainless-steel look

Changeover on
01.01.2023

nolte[®]
KÜCHEN





**Changeover from
week 2/2023**

Top panels Additional circular segments

WA-KR added for 12 mm and 16 mm panel thicknesses



Top panel Circular segments

W12-SB-VAR	W12-KR (new)
W12-B-VAR	
W16-SB-VAR	W16-KR (new)
W16-B-VAR	



Changeover - shelf supports

Shelf supports for **WSTB16 / WSTB** or glass shelves in new design in stainless-steel look and black





Create atmosphere **with light**

Top panels and wall shelves are available in thicknesses of 16 and 25 mm with routed channel for integrated lighting.

- Depths from 200 to 750 mm
 - 200 – 500 mm depth always provided with blind hole and cable entry
 - 501 – 750 mm depth always provided with milled through hole
- Provided for following items:

Top panels

25 mm thick	16 mm thick
WA-B-VAR	W16-B-VAR
WA-HB-VAR	W16-HB-VAR
WA-SB-VAR	W16-SB-VAR

Wall shelves

25 mm thick	16 mm thick
WSTB ...	WSTB16 ...

Following recessed lights can be selected:

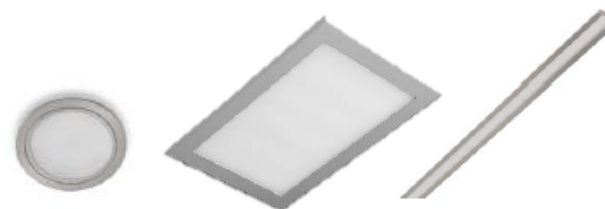

LED-EMO-SR68

LED-PAD

LED-EMO-LUL

LED built-in lights for base and tall shelf units

including routed channel in the carcass sides, now also available for all base and tall shelf units.

LED - LKR - 30/45/60/75/90/105
LED - LKR - 135/150/195/210/225



Additional colours **Glass splashbacks**

The following colours are being added to the existing range of glass splashbacks for greater planning flexibility:

Splashback with toughened safety glass, lacquered on back (NVG...)

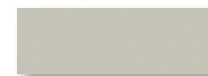

PGG Glass platinum grey lacquered

PLS Glass platinum grey satin finish



GGL Glass graphite lacquered

GSL Glass graphite satin finish



Additional power socket elements

EVOLine® One

Power socket element, single



Single, EVOLine® One

for installing in a material thickness of 10 mm and over in front panels, panels, worktops etc.

Installation drill hole Ø 54 mm
Installation depth 50 mm

SEONE - E stainless steel or black
SEONE - F stainless steel or black
SEONE - G stainless steel or black

EVOLine® One

Power socket element, USB A+C



Double USB charger A/C, EVOLine® One

for installing in a material thickness of 10 mm and over in front panels, panels worktops etc.

Installation drill hole Ø 54 mm
Installation depth 50 mm

SEONE - USB stainless steel or black

EVOLine® Wing

Drawer power socket element, single/USB A+C



Single, double USB charger A/C, EVOLine® Wing

for fitting in drawers/interior drawers, incl. cable management

SEWING - E Black
SEWING - F Black
SEWING - G Black

Inductive charger



Installation drill hole Ø 60 mm
Installation depth 16 mm

Dimensions: diameter 73.8 mm x 18.5 mm

SEQIC Black





WASSERWERK Mixer taps

first-class and lasting quality

Mixer tap with swivelling spout



Colour: black mat
Height: 330 mm
Reach: 230 mm
Turning range: 360°
MIX - 720 - FH - S
High pressure

Mixer tap with swivelling spout



Colour: black mat
Height: 300 mm
Reach: 260 mm
Turning range: 360°
MIX - 730 - FH - S
High pressure

Mixer tap with swivelling spout
and hose spray head



Colour: black mat
Height: 300 mm
Reach: 235 mm
Turning range: 360°
MIX - 731 - SH - S
High pressure

10-
YEAR
WARRANTY

MADE IN
GERMANY 



Downdraft extractors and extractor hoods

Downdraft extractor ALPHA



Glass ceramic induction hob and integrated extractor fan, 780 mm

from cabinet widths of 800 mm

ML 80 - ALPHA - A ducted
ML 80 - ALPHA - U recirculating

Downdraft extractor PRIME S



Glass ceramic induction hob and integrated extractor fan, 830 mm

from cabinet widths of 900 mm

ML 90 - PRIME2 - A ducted
ML 90 - PRIME2 - U recirculating

Downdraft extractor FIT XL



Glass ceramic induction hob and integrated extractor fan, 830 mm

from cabinet widths of 900 mm

ML 90 - FIT - A ducted
ML 90 - FIT - U recirculating

Downdraft extractor STYLO



Glass ceramic induction hob and integrated extractor fan, 800 mm

from cabinet widths of 800 mm

ML 90 - STYLO - A ducted
ML 90 - STYLO - U recirculating

Downdraft extractor GALILEO SMART



Glass ceramic induction hob and integrated extractor fan, 830 mm

from cabinet widths of 900 mm

ML 90 - GALILEO - A ducted
ML 90 - GALILEO - U recirculating

Wall-mounted cooker hood



Wall-mounted extractor hood, 800 mm wide

WH 80 - TWEET - S
Colour: black



nolte
KÜCHEN





NOLTE SPA



Fronts 2023

PG 1



MANHATTAN
Black green
Melamine resin mat



MANHATTAN
Graphite
Melamine resin mat

PG 2



LUX
High-gloss lava
High-gloss
lacquered
laminate

PG 3



PLUS
Lava soft mat
Laminate with
anti-fingerprint finish



PLUS
Graphite soft mat
Laminate with
anti-fingerprint finish

PG 4



SOFT LACK
Black green soft mat
Genuine lacquer



SOFT LACK
Graphite soft mat
Genuine lacquer

PG 6



NOVA LACK
High-gloss graphite
Genuine lacquer



**Carcase / visible sides
panels / open shelf units**
GTD Graphite



Washstand tops 2023



M20 Marble white



C33 Terra nova

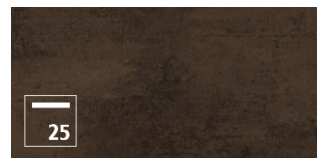

S93 Copper oxide

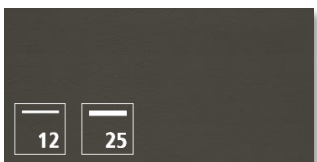

U51 Graphite PRO



E40 Castell oak



E35 Oak barriqué

Handles 2023



G 350
Stainless steel look,
metal ◊ ◊ 160 mm



G 207
Black, metal
◊ ◊ 160 mm



G 336
Stainless steel look,
metal ◊ ◊ 160 mm



G 444
Stainless steel look,
metal ◊ ◊ 192 mm



G 217
Black, metal
◊ ◊ 192 mm



G 9KB
Black, metal
◊ ◊ 192 mm



G 9CA
Polished chrome
metal ◊ ◊ 192 mm



G 9DA
Polished chrome
metal ◊ ◊ 192 mm



G 9EA
Polished chrome
metal ◊ ◊ 192 mm



Vanity units

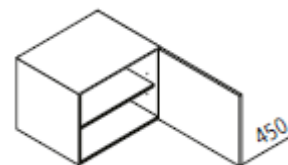

Base unit wall-mounted
1 door, 1 adjustable shelf

Carcase depth 350 mm

UDD 30-45-39-W R/L
UDD 40-45-39-W R/L
UDD 45-45-39-W R/L
UDD 50-45-39-W R/L
UDD 60-45-39-W R/L

Carcase depth 460 mm

UDD 30-45-50-W R/L
UDD 40-45-50-W R/L
UDD 45-45-50-W R/L
UDD 50-45-50-W R/L
UDD 60-45-50-W R/L

Vanity unit washbasins



Ceramic washbasin

in perfect depth (492 mm)
Widths: 600/900/1200 mm
(single washbasin)
1200 mm (DWT –
double washbasin)



**Ceramic counter-top
washbasin**

Gloss white / black mat
Widths: 480 x 480 mm



**Ceramic counter-top
washbasin**

Gloss white and black mat
Widths: 800 x 420 mm



Function mirror



Function mirror with black frame

Touch control
Dimmable
Colour temperature: 3000 K
IP rating IP44
Dimensions: 600 x 750 mm
800 x 750 mm
1000 x 750 mm



Function mirror in oval shape, matching new basin shapes

No operation
Mirror in turning
Colour temperature: 3000 K
IP rating IP44
Dimensions: 500 x 800 mm
500 x 1000 mm



Towel rail

for mounting on carcass
single-arm
Black and chrome





Being discontinued in **2023**



Griffkombination 607
für INTEGRA
Edelstahl-Optik
Metall, 213 / 341 mm



Griffkombination 608
für INTEGRA
Schwarz
Metall, 213 / 341 mm



GRIFF-242 6.00 **
Chrom glänzend
Metall
L: 150 mm / H: 27 mm



GRIFF-243 6.00 **
Chrom matt
Metall
L: 150 mm / H: 27 mm



WTA-01C 40



WTA-02C 50



WTA-KCOLC 40



WTA-KCOLC 38

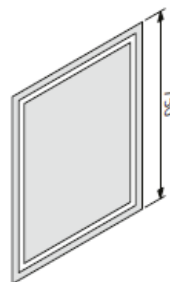

FS05U 60 -75
FS05U 80 -75
FS05U 90 -75
FS05U 100 -75
FS05U 120 -75

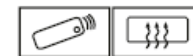
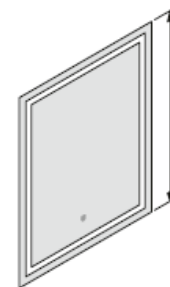

FS06U 60 -75
FS06U 80 -75
FS06U 90 -75
FS06U 100 -75
FS06U 120 -75

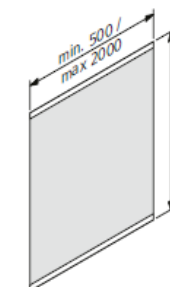

FS08OU-VAR



ZB-HH1-C



INNOVATIONS
2023



PRODUCT GUIDE

2023



2023 Sales Manual

The 2023 sales manual with the new price points is valid from 1.11.2022 and replaces all previous sales documents. Latest delivery date is 31.12. 2023!

The 2023 Sales Manual has 904 pages

Lead text

1. Range overview
2. Base units
3. Worktops
4. Wall units
5. Tall & appliance units
6. MatrixArt
7. Panel system & pilasters
8. Splashbacks, cornices and light pelmets
9. Accessories
New: (sub-)tab for fitted sinks & mixer taps
10. Home living - Nolte LIVING



2023 Sales Manual

New releases for 2023 clearly set out on the first 4 pages.

News 2023

Fronts

PG 1 MANHATTAN UNI
40B Black green 1.04

PG 3 PLUS
60L Lava soft mat 1.12

PG 4 FINE LACK
52A High-gloss arctic white 1.16
52I High-gloss white 1.16
52P High-gloss platinum grey 1.16
52G High-gloss graphite 1.16

PG 4 SOFT LACK
76N Black green soft mat 1.18

PG 6 FRAME LACK
A38 Black green soft mat 1.26

PG 6 TORINO LACK
C38 Black green soft mat 1.28

PG 6 WINDSOR LACK
72N Black green soft mat 1.30

PG 7 LUGANO LACK
Genuine lacquer soft mat Real ash
Available from March 2023

F01 White
F02 Magnolia
F08 Sahara
F07 Lava
F09 Magna
F19 Avocado
F20 Olive
F21 Henna red
F13 Real No
F16 Arctic white
F30 Platinum grey
F03 Quartz grey
F37 Graphite
F38 Black green
F18 Black
F17 Deep blue
F16 Starberry
F06 Opal

Glass recess panelling - NVG 0.12
Colour addition

PGG Glass platinum grey lacquered
PLS Glass platinum grey satin finish
GGL Glass graphite lacquered
GSL Glass graphite satin finish

News 2023

Surroundings

Fold-out

Decor group 1
Melamine resin, mat
BGD Black green

Decor group 2
Laminate AFP
SAL Lava soft mat
LM8 Lacquer, black green soft mat

Decor group 4
Genuine lacquer soft mat

ERW Lacquer, repro. ash, white soft mat
ERU Lacquer, repro. ash, avocado soft mat
ERA Lacquer, repro. ash, arctic white soft mat
ERZ Lacquer, repro. ash, black soft mat

ERM Lacquer, repro. ash, magnolia soft mat
ERV Lacquer, repro. ash, olive soft mat
ERL Lacquer, repro. ash, platinum grey soft mat
ERT Lacquer, repro. ash, deep blue soft mat

ERS Lacquer, repro. ash, sahara soft mat
ERIS Lacquer, repro. ash, henna red soft mat
ERQ Lacquer, repro. ash, quartz grey soft mat
ERB Lacquer, repro. ash, blueberry soft mat

ERL Lacquer, repro. ash, lava soft mat
ERH Lacquer, repro. ash, rose hip soft mat
ERK Lacquer, repro. ash, graphite soft mat
ERD Lacquer, repro. ash, opal soft mat

ER9 Lacquer, repro. ash, magna soft mat
ERH Lacquer, repro. ash, rose hip soft mat
ERK Lacquer, repro. ash, graphite soft mat
ERD Lacquer, repro. ash, opal soft mat
ER9 Lacquer, repro. ash, magna soft mat
ERH Lacquer, repro. ash, rose hip soft mat
ERK Lacquer, repro. ash, graphite soft mat
ERD Lacquer, repro. ash, opal soft mat

	Decor group 1 Melamine resin, mat	Decor group 2 Laminate AFP	Decor group 4 Genuine lacquer soft mat	Decor group 1 Melamine resin, mat	Decor group 2 Laminate AFP	Decor group 4 Genuine lacquer soft mat
D1 Melamine resin, mat						
BGD Black green						
D3 Laminate AFP						
SAL Laminate AFP lava soft mat						
D4 Genuine lacquer soft mat						
LM8 Lacquer, black green soft mat						
D4 Genuine lacquer repro. ash soft mat						
All colors						

2023 Sales Manual

New arrangement for discontinued products

- No longer any guaranteed subsequent availability
- Complete kitchens up to 31.03.2023 for delivery up to 30.06.2023
- Once the ordering deadline expires, only a limited number of materials will be available.
- Delivery for add-on orders up to 31.12.2023

Discontinued products 2023

Orders and add-on deliveries for front ranges and surrounding elements that are being discontinued:

As an innovative kitchen manufacturer, we are constantly developing trend-setting products for the kitchen and living-room. This also includes updating the entire product portfolio. Complete kitchens with fronts and surrounding elements that are being discontinued can be ordered until 31.03.2023 for delivery before 30.06.2023. A limited number of fronts and materials for surrounding elements will be available for add-on orders after the order period has expired. Add-on orders need to be agreed in writing with the internal sales team in advance. The last possible delivery date for add-on orders is 31.12.2023. Delivery times for ranges that are being discontinued are generally longer.

Subsequent delivery under reserve

Fronts



Glass doors



Surroundings

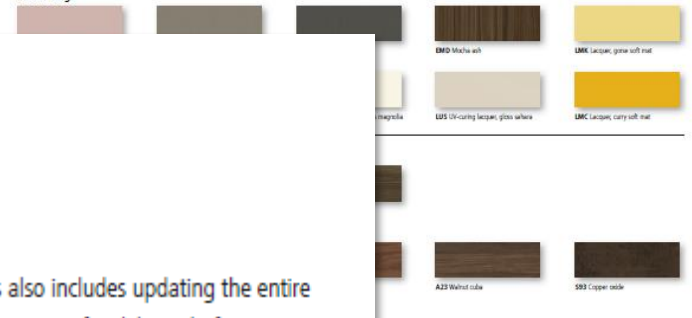

Discontinued products 2023

Orders and add-on deliveries for front ranges and surrounding elements that are being discontinued:

As an innovative kitchen manufacturer, we are constantly developing trend-setting products for the kitchen and living-room. This also includes updating the entire product portfolio. Complete kitchens with fronts and surrounding elements that are being discontinued can be ordered until 31.03.2023 for delivery before 30.06.2023. A limited number of fronts and materials for surrounding elements will be available for add-on orders after the order period has expired. Add-on orders need to be agreed in writing with the internal sales team in advance. The last possible delivery date for add-on orders is 31.12.2023. Delivery times for ranges that are being discontinued are generally longer.

Subsequent delivery under reserve

2023 nolteneo Sales Manual

The 2023 nolte**neo** Sales Manual with the new price points is valid from 01.11.2022 and replaces all previous sales documents.

Latest delivery date is 31.12.2023!

The 2023 Sales Manual has 996 pages

neo lead text

Nolte lead text

1. Range overview
2. Base units
3. Worktops
4. Wall units
5. Tall & appliance units
6. MatrixArt
7. Panel system & pilasters
8. Splashbacks, cornices and light pelmets
9. Accessories
New: (sub-)tab for fitted sinks & mixer taps
10. Home living - Nolte LIVING



PRODUCT GUIDE

2023

